

**GENERAL SPECIFICATIONS**

Model	PC9501N		PC6501N	
	120V (UC)/240V(A)	230 (EU)	120V (UC)/240V(A)	230 (EU)
<b>Output Power</b>	8Ω/STEREO 1000W+1000W	1050W+1050W	700W+700W	750W+750W
1kHz	4Ω/STEREO 1600W+1600W	1650W+1650W	1100W+1100W	1150W+1150W
THD+N=1%	8Ω/BRIDGE 3200W	3300W	2200W	2300W
20-20kHz	8Ω/STEREO 925W+925W	950W+950W	650W+650W	650W+650W
THD+N=0.1%	4Ω/STEREO 1400W+1400W	1500W+1500W	930W+930W	930W+930W
	8Ω/BRIDGE 2800W	3000W	1860W	1860W
1kHz	2Ω/STEREO 2300W+2300W	2300W+2300W	1500W+1500W	1600W+1600W
20mS nonclip	4Ω/BRIDGE 4600W	4600W	3000W	3200W
<b>Sensitivity</b>		+9dB		+8dB
RL=8Ω Att. max				
<b>S/N Ratio</b>		106dB		105dB
20Hz-20kHz (DIN AUDIO)				
<b>Idle Power Consumption</b>		55W		40W
1/8 Power Consumption (4Ω)		750W/1000W	1100W	700W/800W
				800W

Model	PC4801N		PC3301N	
	120V (UC)/240V(A)	230 (EU)	120V (UC)/240V(A)	230 (EU)
<b>Output Power</b>	8Ω/STEREO 550W+550W	500W+500W	350W+350W	400W+400W
1kHz	4Ω/STEREO 850W+850W	800W+800W	600W+600W	700W+700W
THD+N=1%	8Ω/BRIDGE 1700W	1600W	1200W	1400W
20-20kHz	8Ω/STEREO 475W+475W	450W+450W	330W+330W	350W+350W
THD+N=0.1%	4Ω/STEREO 725W+725W	700W+700W	525W+525W	550W+550W
	8Ω/BRIDGE 1450W	1400W	1050W	1100W
	16Ω/100V/BRIDGE	—	625W	625W
1kHz	2Ω/STEREO 1200W+1200W	1200W+1200W	800W+800W	900W+900W
20mS nonclip	4Ω/BRIDGE 2400W	2400W	1600W	1800W
<b>Sensitivity</b>		+6dB		+4.5dB
RL=8Ω Att. max				
<b>S/N Ratio</b>		103dB		101dB
20Hz-20kHz (DIN AUDIO)				
<b>Idle Power Consumption</b>		40W		40W
1/8 Power Consumption (4Ω)		450W/600W	600W	450W/500W
				500W

Model	PC2001N	
	120V (UC)/240V(A)	230 (EU)
<b>Output Power</b>	8Ω/STEREO 230W+230W	250W+250W
1kHz	4Ω/STEREO 400W+400W	450W+450W
THD+N=1%	8Ω/BRIDGE 800W	900W
20-20kHz	8Ω/STEREO 200W+200W	230W+230W
THD+N=0.1%	4Ω/STEREO 325W+325W	400W+400W
	8Ω/BRIDGE 650W	800W
1kHz	2Ω/STEREO 500W+500W	600W+600W
20mS nonclip	4Ω/BRIDGE 1000W	1200W
<b>Sensitivity</b>		+3dB
RL=8Ω Att. max		
<b>S/N Ratio</b>		100dB
20Hz-20kHz (DIN AUDIO)		
<b>Idle Power Consumption</b>		40W
1/8 Power Consumption (4Ω)		350W
		350W

**PC-1N Series Dimensions**

unit : mm

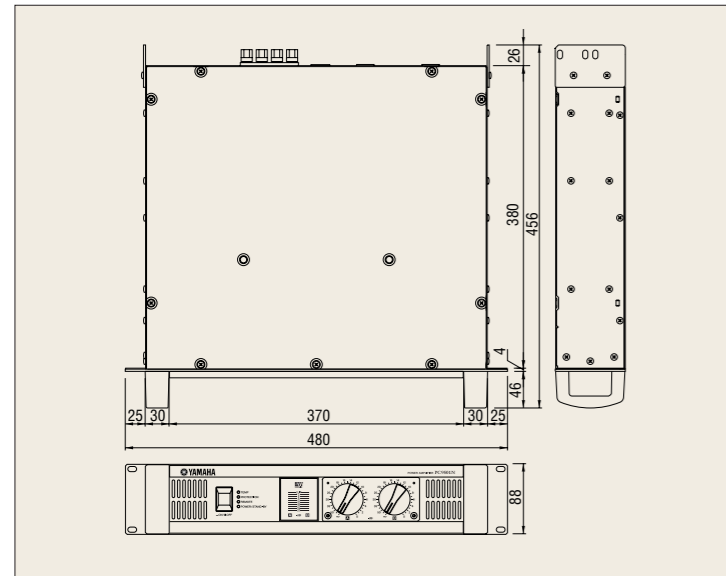

		All Models
<b>Power Bandwidth</b>	half power THD+N=0.5%	10Hz-40kHz
<b>THD+N</b>	20Hz-20kHz, half power	0.1%
<b>Intermodulation Distortion</b>	60Hz: 7kHz, 4:1, half power	0.1%
<b>Frequency Response</b>	RL=8Ω Po=1W	0dB, -1dB f=20Hz-50kHz
<b>Channel Separation</b>	half power RL=8Ω 1kHz Att. max Input 600Ω shunt	≥ 70dB
<b>Residual Noise Att. min</b>	20Hz-20kHz (DIN AUDIO)	≤ -70dB
<b>Damping Factor</b>	RL=8Ω 1kHz	800 (except PC2001N)/500 (PC2001N)
<b>Voltage Gain Att. max</b>		32dB
<b>Maximum Input Voltage</b>		22dB
<b>Input Impedance</b>		20kΩ (balance) 10kΩ (unbalance)
<b>Controls</b>	Front Panel	POWER switch (push on/push off) attenuator (31 position) x 2
	Rear Panel	MODE switch (STEREO/BRIDGE/PARALLEL) HPF switch (ON/OFF f=20Hz 12dB/oct) AMP ID switch (6PDIP) x 1
<b>Connectors</b>	Input	XLR-3-31 type/ch Euroblock connector (balance)/ch
	Output	SPEAKON/ch, 5way biding post x 1
	DATA PORT	RJ45 x 2
	Power	AC inlet x 1
<b>Indicators</b>	POWER/STAND-BY	x 1 (Green/Orange)
	PROTECTION	x 1 (Red)
	TEMP	x 1 (Red) heatsink temp ≥ 85°C
	REMOTE	x 1 (Green)
<b>Level Meters</b>		10 points LED meter/ch
<b>Load Protection</b>		POWER switch on/off mute DC-fault power supply shutdown
<b>Amplifier Protection</b>		Thermal (heatsink temp ≥ 90°C) VI limiter (RL ≤ 1Ω)
<b>Limitter Circuit</b>		Clip limiting : THD ≥ 0.5%
<b>Cooling</b>		Dual Variable-speed fan
<b>Power Requirements</b>	UC	120V / 60Hz
	EU	230V / 50Hz
	A	240V / 50Hz
<b>Dimensions (W x H x D)</b>		480 x 88 x 456 mm (18-7/8" x 3-7/16" x 17-15/16")
<b>Weight</b>		12.5 Kg (27.6 lbs) (except PC9501N) 13kg (PC9501N)

• 0dB=0.775V • half power=1/2 output power  
 \* CobraNet is a registered trademark of Peak Audio, a Division of Cirrus Logic.  
 Speakon is a registered trademark of Neutrik AG.  
 For more details about CobraNet and recommended Ethernet products, visit the website: <http://www.peakaudio.com/>.  
 UC : US & Canadian Models  
 EU : European models  
 A : Australian Models



**POWER AMPLIFIER**  
**PC-1N**  
**series**



For details please contact:

• Specifications and appearance are subject to change without notice.

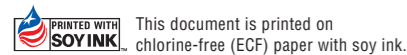

<http://www.yamahaproaudio.com>

LPA498 Printed in Japan

# Meet the latest Yamaha milestones on the road to perfect sound.

Excellent Sound Quality, Exceptional Reliability

A full model change brings Yamaha's legendary high-end PC-N power amplifier series to the next exciting level — the PC-1N Series.

The new PC-1N Series features a powerful low range, rich mid range and high-definition high range, plus fast response and exceptional stability for optimum sound quality even with serious power supply limitations. Refinements throughout and expanded 5-model lineup make this the new benchmark for the quality, reliability and application versatility today's professionals demand.

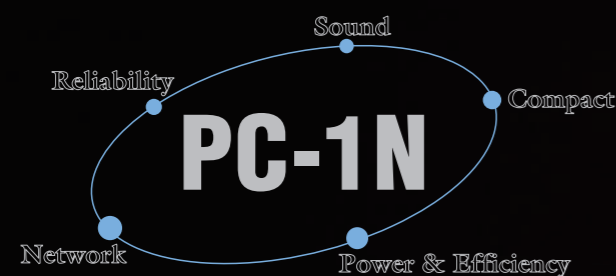

- Rethought, redesigned, reworked circuitry and component layout plus uncompromising part selection — including environmentally friendly lead-free parts — are two big reasons for the PC-1N's trademark sound quality, balance and separation.
- The high-reliability, high-efficiency power supply guarantees clear, powerful sound even with serious power supply limitations.
- Yamaha's proprietary EEEngine (Energy Efficient Engine) technology delivers high performance with exceptional efficiency — for 50% less power consumption than conventional Class-AB amplifiers.\*
- Multiple protection circuits and large heat sinks guarantee maximum operating stability.
- Combining PC-1N models with ACU16-C Amplifier Control Units and NHB32-C Network Hub Bridges gives users large-scale network system capabilities.
- The PC-1N's comprehensive I/O interface selection — XLR, Euroblock and Speakon connectors — make it an ideal choice for applications from installed sound systems to public address systems.
- The standardized lightweight, compact body weighs only 12.5 kg\*\* and measures a mere 2U in height — making PC-1Ns easier than ever to carry or install.

\* Previous Yamaha Class-AB amplifiers.

\*\* The PC9501N weighs 13 kg.



**PC9501N** • Rated power: 2 x 925 watts @ 8 ohms, 2 x 1400 watts @ 4 ohms • Dynamic power: 2 x 2300 watts @ 2 ohms • Power consumption: 750 watts • 2U, 13kg

**PC6501N** • Rated power: 2 x 650 watts @ 8 ohms, 2 x 930 watts @ 4 ohms • Dynamic power: 2 x 1500 watts @ 2 ohms • Power consumption: 700 watts • 2U, 12.5kg

**PC4801N** • Rated power: 2 x 475 watts @ 8 ohms, 2 x 725 watts @ 4 ohms • Dynamic power: 2 x 1200 watts @ 2 ohms • Power consumption: 450 watts • 2U, 12.5kg

**PC3301N** • Rated power: 2 x 330 watts @ 8 ohms, 2 x 525 watts @ 4 ohms • Dynamic power: 2 x 800 watts @ 2 ohms • Power consumption: 450 watts • 2U, 12.5kg

**PC2001N** • Rated power: 2 x 200 watts @ 8 ohms, 2 x 325 watts @ 4 ohms • Dynamic power: 2 x 500 watts @ 2 ohms • Power consumption: 350 watts • 2U, 12.5kg

\* These figures are based on US 120V specifications. See the specifications list in the back of this catalogue for details.

# POWER AMPLIFIER PC-1N series

Unparalleled sound quality and reliability.  
Driving power and slashed power consumption.  
Add advanced networking control capability and  
you've got the ultimate power amp series — the PC-1N.

PC9501N  
PC6501N  
PC4801N  
PC3301N  
PC2001N



### Maximum sound quality with minimum distortion for a new dimension in powerful, clear sound.

From the start, the new PC-1N Series had a lot to live up to. As the next generation in Yamaha's flagship PC lineup, it had to deliver the same exceptional standards of clear separation and rapid response while taking sound quality to the next level.

Yamaha audio engineers went to work examining every detail of sound quality. Which led to breakthrough-level innovations in circuitry and internal wiring. Meticulous part selection — including environmentally friendly lead-free parts — and innovative combinations. And new circuit board mounting methods to absorb unnecessary vibrations. They also analyzed feedback from public address professionals on-site and tested prototypes with commitment bordering on obsession.

The results were worth it. Results like the highest level of sound quality with the lowest level of distortion available. Clear and transparent, yet powerful and robust. A responsive, dynamically energetic low range, rich, mellow mid range and high-resolution high range. The bottom line? The PC-1N Series features dynamic, deep, detailed sound with exceptional balance — the kind of performance that "runs in the family".

### Five models featuring lightweight, compact design — 12.5 kg, 2U — for maximum versatility and convenience in any application.

Each PC-1N model comes housed in a standard compact 2U chassis. Even with the dominating power rating of 900 watts per channel, the PC9501N (2 x 900 watts @ 8 ohms) weighs only 13 kg — 50% less than conventional same-class models\* with power transformers. There's also the PC6501N (2 x 650 watts @ 8 ohms), PC4801N (2 x 450 watts @ 8 ohms), PC3301N (2 x 315 watts @ 8 ohms) and PC2001N (2 x 200 watts @ 8 ohms) — all featuring the kind of sound quality and reliability that only the PC Series can deliver.

\* Previous Yamaha models.

### New advanced switching regulator and high-efficiency EEEEngine technology

Thanks to Yamaha's advanced new switching regulator and high-efficiency EEEEngine technology, the PC-1N Series features high-quality sound and exceptional power with slashed power consumption and new compact size. The switching regulator stabilizes output voltage and current — even when line voltage varies — for maximum efficiency drive. Which means that, unlike conventional linear power supplies that use a transformer, the switching regulator guarantees balanced sound with no instability even at high output levels. What's more, the improved amp drive efficiency as a

result of the switching regulator is the key behind other important PC-1N features like reduced heat loss, longer part life, lighter weight, more compact size and lower power consumption. And thanks to the advanced switching regulator and other refinements, the PC-1N's switching regulator features the highest performance ever — clear, stable, high-quality sound in installed sound systems with long power cables and outdoor, large-scale public address applications with unstable primary power sources.

Next, EEEEngine technology is the key to slashing power consumption without sacrificing sound quality. The independent auxiliary power line and high-speed voltage buffer feature split-second response capabilities to fast attack sound. What's more, new MOSFET (Metal Oxide Semiconductor Field Effect Transistor) circuitry in the high-efficiency current buffer is why the PC-1N Series boosts efficiency to a phenomenal 200% — 50% lower power consumption — over conventional Class-AB amplifiers.\* The PC9501N, for instance, draws a mere 950 watts of power when driven at maximum power with channels into 4-ohm loads.

\* Yamaha's previous Class-AB amplifiers.

### Internal layout with innovative features for higher sound quality and reliability

The PC-1N series features smaller components across the board thanks to the all new drive efficiency made possible by the new switching regulator and

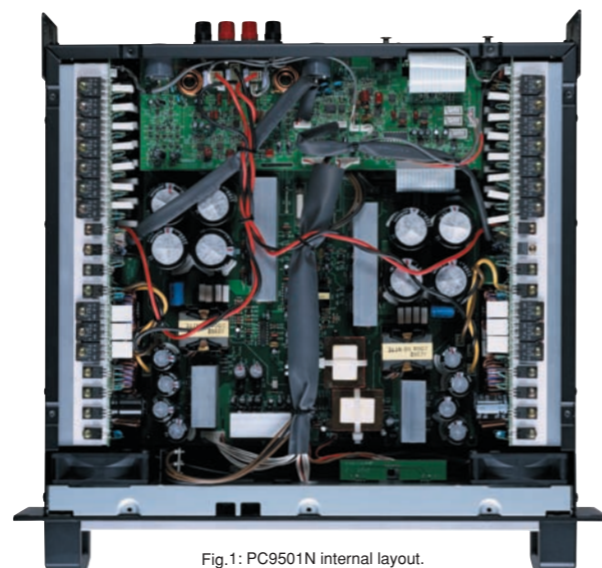

Fig.1: PC9501N internal layout.

EEEEngine technology. Smaller part size, in turn, gave Yamaha engineers new freedom in component layout — offering a wider range of alternatives in choosing parts, circuit design and internal layout designed to maximize sound quality and reliability. As you can see in Fig.1, PC-1N models feature an extremely symmetrical layout with optimal part configurations. Circuit boards prone to high heat generation, for instance, have been fitted on both sides of the amplifier with large heat sinks and low-noise stepless variable-speed cooling fans. This arrangement also absorbs vibration noise from the transistors and circuit boards. What's more, as shown in Fig.2 below, heat sinks are mounted on the side panel with screws at multiple locations with insulators between screws and heat sink to eliminate chassis resonance that can cause noise.

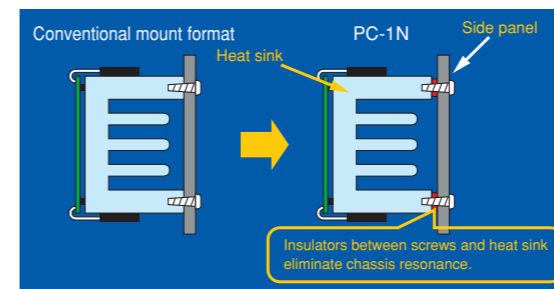

Fig.2

### Easy-to-read indicators and comprehensive protection circuitry

The PC-1N features an impressive array of protection circuitry and indicators to ensure stable operation and accurate monitoring. The front panel's 10-segment LED level meters guarantee accurate level monitoring — even under poor lighting conditions. If output signal distortion exceeds 1%, the red "CLIP" indicator lights and the PC limiter activates automatically. In terms of DC voltage protection, surges of excess current activate the speaker protection circuitry and cause the "PROTECTION" indicator to light. What's more, the high-efficiency EEEEngine prevents against overheating under almost any circumstances. However, the "TEMP" lamp illuminates if heat sink temperature rises above 85. And at temperatures over 90, the thermal protection circuit automatically shuts down the system — for a fail-safe protection environment.

There's more. The 31-step-detented level controls for channels A and B come with a security cover to prevent control settings from being changed accidentally. The "POWER/STAND-BY" indicator does double duty; green means the power is on, while orange notifies users of a "stand-by" command from the connected external control unit. And the "REMOTE" on the rear

panel illuminates when control signals are received from an external device connected to the DATA port.

### Three drive modes guarantee maximum application flexibility

All PC-1N models feature stereo, dual mono and bridged mono modes for the ultimate in versatility. In the Stereo mode, the two channels are independent. The Parallel (dual mono) mode allows a single, mono input signal to drive two independent speaker systems. And in the Bridge mode, the two channels work together as one, pumping out maximum power. What's more, the rear panel MODE switch lets you change modes quickly and easily for top versatility any time, anywhere. In terms of individual model capabilities, the PC3301N was specially designed for use as a distribution amplifier to drive multiple speakers in installed sound systems based on its ability to drive high-impedance loads using multiple 100-volt line output speakers in parallel.

### Multiple I/O connections plus subsonic filter cut unwanted low frequencies

The comprehensive array of rear panel terminals and connectors let you use the PC-1N Series with the widest possible range of systems and equipment. Balanced XLR (XLR3-32) and Euro-block terminals are featured as inputs for quick, easy connection. All models also come with a built-in high-pass (subsonic) filter that eliminates frequencies below 20Hz. On the output side, 5-way heavy-duty binding-post terminals and Speakon™ connectors ensure solid, reliable speaker connections. Finally, all models are equipped with a lockable/detachable power supply connector.

### Remote amplifier monitoring/control with cutting-edge CobraNet™ audio networking interface

Each PC-1N model can be connected to a Yamaha ACU16-C amplifier control unit (optional) and Windows PC through its rear-mounted RJ-45 connector — to let you monitor/control the amplifiers and speakers connected to it. You can control AMP ID settings with the unit's 5-bit DIP switch and up to 32 PC-1N serial interface connections with one ACU16-C. If a protection system is activated in any of the amplifiers, the PC's NetworkAmp Manager software automatically displays a pop-up warning window and logs current parameters for quick, easy trouble shooting — even in complex amp systems. What's more, the NHB32-C Network Hub/Bridge (optional) lets you monitor/control the entire system via CobraNet™ — as well as using the ACU16-C as a high-quality 24-bit DA converter.



PC4801N REAR PANEL

# NetworkAmp Manager

## Dedicated ACU16-C amp control unit and NHB32-C network hub bridge software for cutting-edge digital SR networks.

NetworkAmp Manager software comes with ACU16-C and NHB32-C.

- Operating systems: Windows 98/98SE/ME/2000/XP
- Minimum display resolution: 1024 x 768 or greater, 32,000 colors

### Full PC monitoring/control capabilities of extended PC-1N+ACU16-C+NHB32-C systems

The NetworkAmp Manager is a dedicated software program that lets you monitor and control extended networks of PC-1N amplifiers, ACU16-Cs and NHB32-Cs. And we *do* mean extended. In fact, with a computer running Windows, you can call the shots for up to eight NHB32-C hubs, sixteen ACU16-C control units and an incredible 512 PC-1N amplifiers! Just connect the USB port on your NetworkAmp Manager-installed PC or the COM to any ACU16-C or NHB32-C in your network — and you've got the power of full remote monitoring and control for every single device at your fingertips.

### PC-1N and ACU16-C monitoring/control functions

NetworkAmp also lets you monitor/control the operating status of each amplifier in your system via the ACU16-C. With each ACU16-C handling up to 32 PC-1N amplifiers, you can easily keep track of and manage specific amp groups. The channel detail screens provides detailed graphic monitoring/control capabilities for each channel — so you can monitor/control Power On/Stand-by, attenuation, Phase, Mute (On/Off), Input/Output meters, heat sink temperature and Load Impedance.



Amp Monitoring / Group View



Amp Monitoring / Channel Detail View

### Warnings and automated Warning Log for efficient troubleshooting

NetworkAmp Manager uses the ACU16-C's amp control functions to warn users when parameter values exceed user-set thresholds for Wattage, Temperature or Impedance (Upper/Lower) settings. When a warning window appears, the software records the parameter data as a log file — both at the time of the warning and immediately before. This convenient feature lets you pinpoint specific problems and conduct precise, accurate troubleshooting quickly and easily simply by checking the data in the log file.

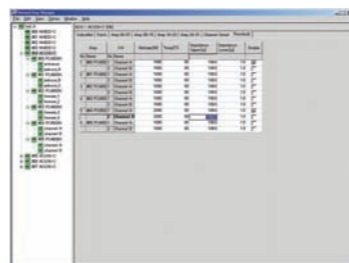

Amp Monitoring / Threshold

### NHB32-C network hub/bridge function control

The NHB32-C network hub/bridge features CobraNet™ — with one NHB32-C letting users receive or transmit up to 32-channel AES/EBU digital audio signals to CobraNet™. Not only can CobraNet™ transfer eight channels of 20-bit data or seven channels of 24-bit data in single bundles across the network, but NetworkAmp Manager can be used to assign input and output of the bundled audio data.

### ACU16-C offers D/A conversion and analog output assignment

The ACU16-C's D/A conversion function can convert any 16 channels of up to 32 digital audio signal channels received through CobraNet™ into high-quality analog audio signals. You can also specify which bundles to acquire from CobraNet™ with NetworkAmp Manager.

## CobraNet™

CobraNet™ is state-of-the-art networking technology that transmits and receives uncompressed digital audio signals and controls signals real-time via 100Base-T Ethernet cables. Using 100 Base-TX cables, traffic is carried with fixed latencies of 1.33ms, 2.66ms or 5.33ms for distances of up to 200-meters (two 100-meter cables connected by a switching hub). What's more, CobraNet™ can operate with a standard Ethernet system — for superior ease of installation and cost performance.

The amp control unit featuring PC-1N series control and monitoring capabilities plus CobraNet™ compatibility.

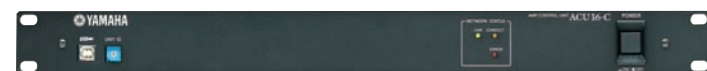

## AMP CONTROL UNIT ACU16-C

The network hub/bridge for CobraNet™ networking with up to 32-channel digital audio and control signal reception/transmission capabilities.



## NETWORK HUB / BRIDGE NHB32-C

## System Examples

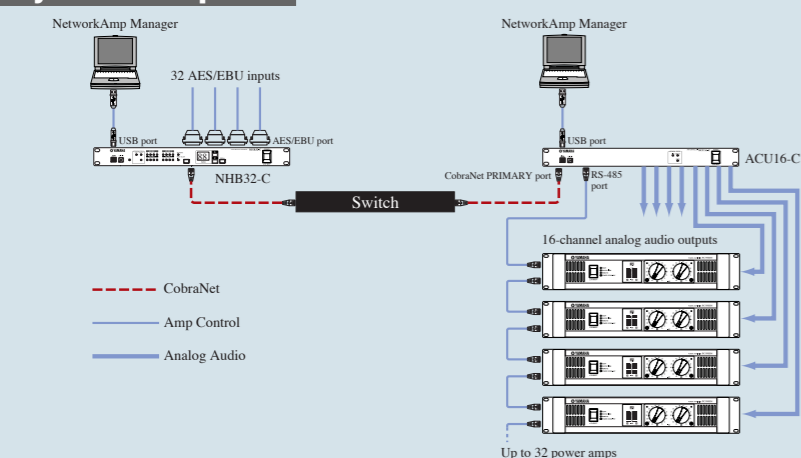

### Monitoring and control of multiple amplifiers with NetworkAmp Manager

- The ACU16-C amplifier control unit and a PC running NetworkAmp Manager can monitor/control the operating conditions of up to 32 PC-1N amplifiers, including power, attenuation, inputs, outputs, temperature and load impedance.
- A PC running NetworkAmp Manager can be connected not only to an ACU16-C via a USB port, but also to an NHB32-C network hub/bridge on the CobraNet™ network. This versatility gives you full remote amp control capability — for dramatically improved operating efficiency.
- Using CobraNet™, the ACU16-C's D/A conversion function can convert up to 16 channels of digital audio signals to high-quality 48KHz/20-bit or 24-bit analog audio signals.
- One CobraNet™ network can be used to connect up to 8 NHB32-C units and 16 ACU16-C units — giving you the freedom to configure large-scale audio networks.



Yamaha state-of-the-art EEEngine technology features exceptional power, maximum-efficiency drive performance and unsurpassed power efficiency — while delivering the same high sound quality today's professionals demand.

Thanks to 50% lower power consumption than conventional amplifiers\*, Yamaha's revolutionary EEEngine technology can effortlessly drive amplifiers under conditions involving additional lighting equipment or other power supply constraints. EEEngine cuts heat loss to less than 35%\* that of conventional units — allowing more lightweight, compact chassis, lower electricity costs, less thermal damage and longer part life.

\* Compared to previous Yamaha's products in actual use situations.

### Innovative circuitry design for stable, efficient voltage supply

Power amplifiers normally have a Class AB (single-ended push-pull) output stage and supply their output transistors with voltage capable of generating maximum output at any time. Over the years, sound engineers devised a comprehensive array of new formulas and systems to boost amplifier drive efficiency, but their efforts were unsuccessful in delivering significantly lower power consumption levels while maintaining high-quality, powerful sound. Until Yamaha's EEEngine technology, that is.

As shown in Fig.3, EEEngine uses high-efficiency switching and smoothing circuits to supply the power necessary for maximum amp drive efficiency according to the input signal level (Fig.4). Clipping occurs in conventional smoothing circuits required for switching circuits due to unstable voltage caused by high-amplitude input signals. EEEngine eliminates this drawback with an independent fast-response auxiliary power supply circuit. The result? Sufficient power can be seamlessly delivered to complement the main power supply in response to input amplitude changes — for stable, high-quality sound even with high-amplitude input.

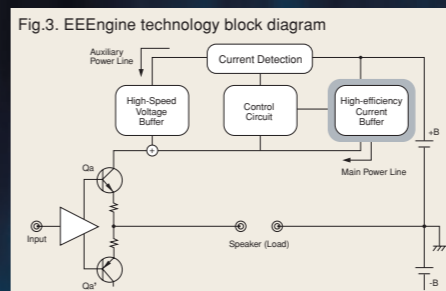
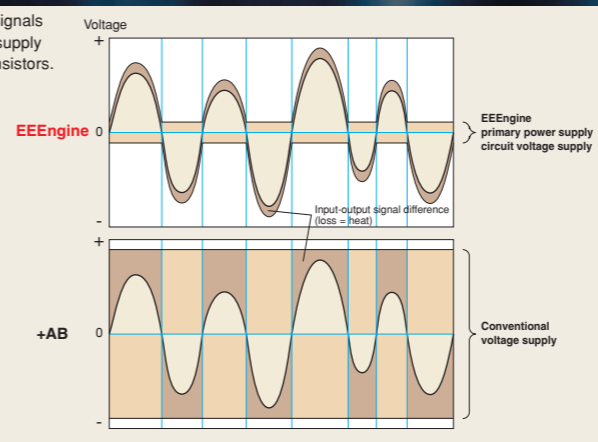

Fig.4. Input signals and voltage supply to output transistors.



### Ultra-high-speed response to fast attack sound.

Since EEEngine's auxiliary power supply circuit is designed to complement the primary power supply circuit to draw maximum output, PC-1N models feature ultra-high-speed response to fast attack sound. That means you enjoy all the advantages of a "fast amp" plus lower power consumption. The primary power supply circuit provides a high-efficiency power supply under normal conditions — to keep the average current value small and dramatically reduce power loss even when the fast-response auxiliary power supply circuit is driven by an ample power supply (Fig.5).

Fig.5. Efficiency comparison data (power consumed vs. output)

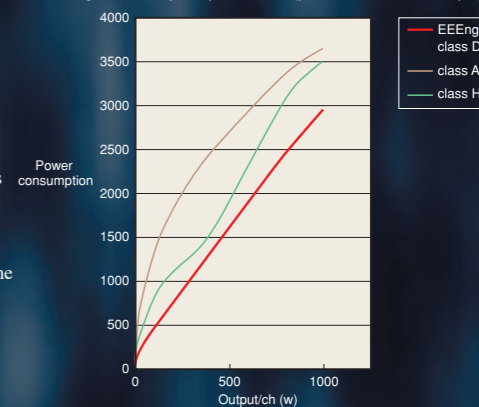

### Longer part life, better reliability

The rule of thumb in component longevity is that you can double part life by cutting drive temperature by 10°. And since EEEngine technology cuts heat loss to 35% that of conventional technologies, the longer part life you enjoy as a result means a dramatic improvement in PC-1N reliability (Fig.6).

Fig.6. Efficiency comparison data (heat vs. output)

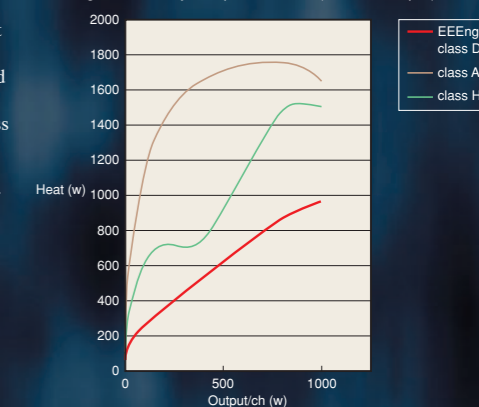

## PC-1N Block Diagram

